

Bidet-Einhandbatterie mit Ablaufgarnitur - Chrom





MEM

33 600 782



- Ausladung 110 mm
- Kugelgelenk 44° schwenkbar
- rechteckiger luftangereicherter Strahl
- Armaturenhöhe 180 mm
- Höhe bis Luftsprudler 140 mm
- Bohrungsdurchmesser 35 mm
- 2x Druckschlauch M 10 x 1 eingeschraubt, dichtheitsgeprüft
- Durchfluss max. 6 l/min

Passt zu: MEM, CYO

	Chrom	33 600 782-00
	Platin gebürstet	33 600 782-06
	Platin	33 600 782-08
	Dark Chrome	33 600 782-19
	Messing gebürstet (23kt Gold)	33 600 782-28
	Champagne gebürstet (22kt Gold)	33 600 782-46
	Champagne (22kt Gold)	33 600 782-47
	Dark Platin gebürstet	33 600 782-99

33 600 782

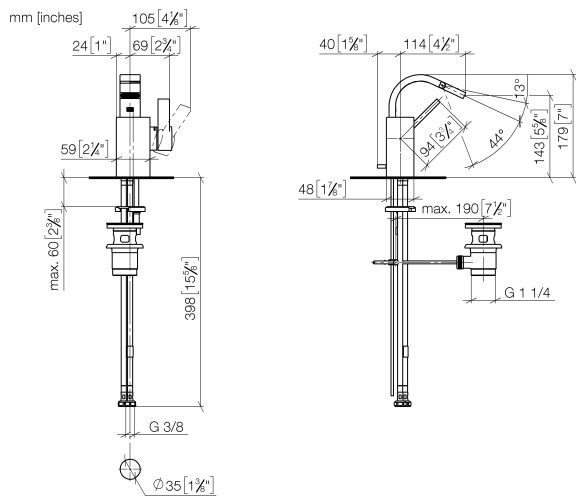

Durchflussdiagramm

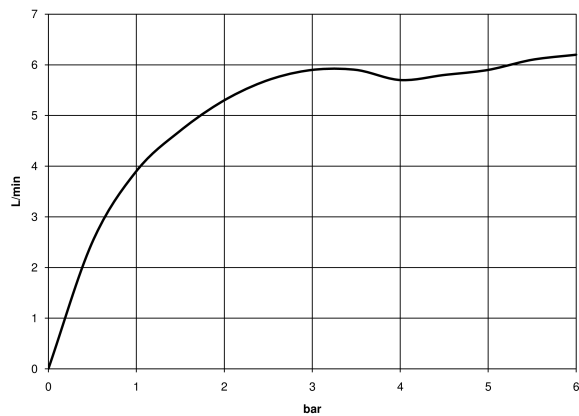

Zertifikate

LGA_28444. WRAS_1807016. WRAS_240202017.

33 600 782

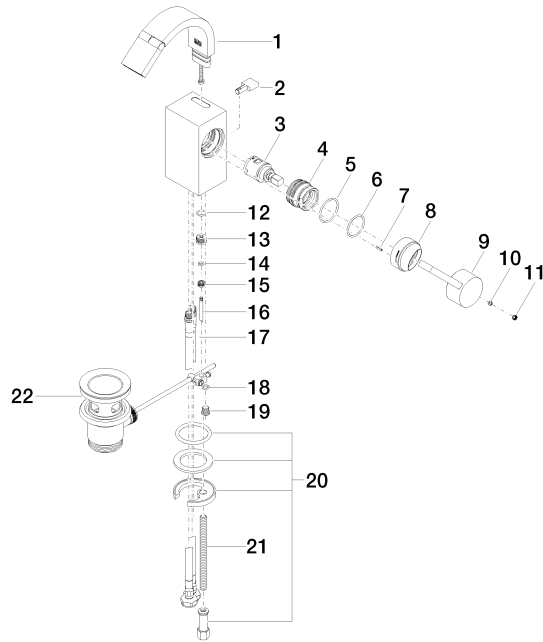

33 600 782

Ersatzteilstückliste

Nr.	Artikelnummer	Benennung	Verbaumenge	Lieferzeit
1	90 28 22 265 00-00	Auslauf	1	10
2	09 20 78 032-00	Griff	1	10
3	90 15 05 042 00 90	Kartusche	1	2
4	09 24 04 288 90	Mutter	1	2
5	09 14 10 137 90	Dichtung	1	2
6	90 14 10 063 00 90	Dichtung	1	2
7	09 31 11 152 90	Stift	1	2
8	09 28 30 028-00	Haube	1	10
9	09 20 78 057-00	Griff	1	10
10	90 31 11 063 00 90	Stift	1	2
11	90 31 20 109 00 90	Stopfen	1	2
12	09 14 10 042 90	Dichtung	1	2
13	09 24 04 289-00	Nippel	1	10
14	09 14 10 166 90	Dichtung	1	2
15	09 24 04 290 90	Nippel	1	2
16	09 31 09 080-00	Zugstange	1	10
17	04 30 04 104 00 90	Schlauch	2	2
18	09 14 10 132 90	Dichtung	1	2
19	09 31 20 027 10-00	Stopfen	1	10
20	04 30 11 038 75 90	Befestigungssatz	1	2
21	09 31 11 012 90	Stift	1	2
22	90 11 01 001 00-00	Ablaufgarnitur	1	10